

PUERTAS

PLACAS

LAC CORR[®]





HOJA ENCHAPADA CEDRO



LISA

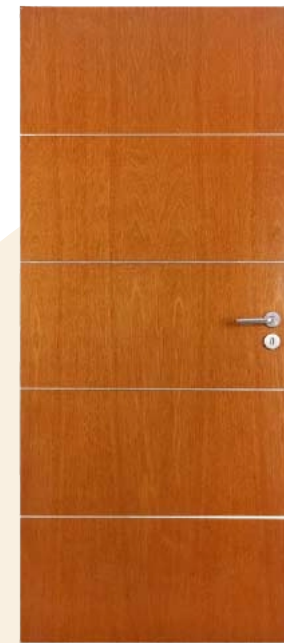

INSERTOS
ALUMINIO



HOJA ENCHAPADA PINO



HOJA MDF



LISO

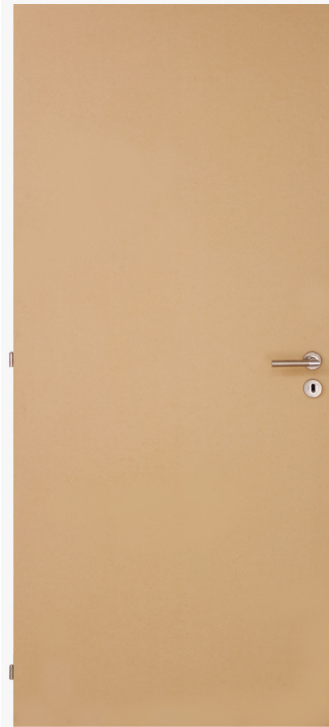

↑
3/5.5/9mm

ALUMINIO



↑
5.5mm

ORIENTE



↑
5.5/9mm

ESTABLO

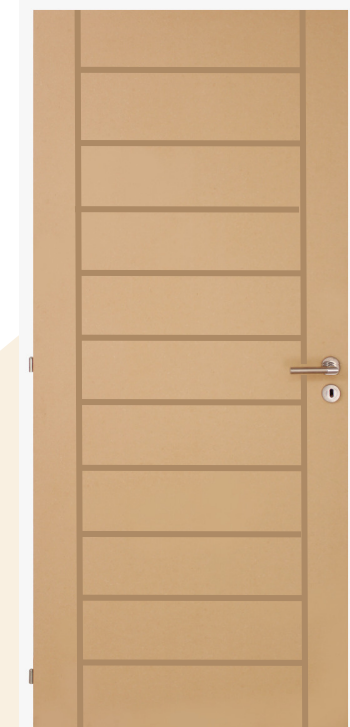



HOJA

MDF

MOLDURADO 9mm



2 TABLEROS
RECTOS



3 TABLEROS
RECTOS



2 TABLEROS
1/4 PUNTO

HOJA

TEXTURADA

3mm

con base blanca



MARCOS

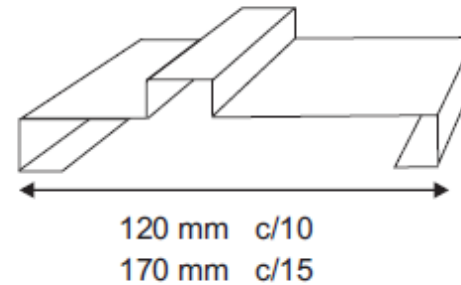

**GRAMPAS DE
AMURE
BIFUNCIONAL**

CHAPA 18

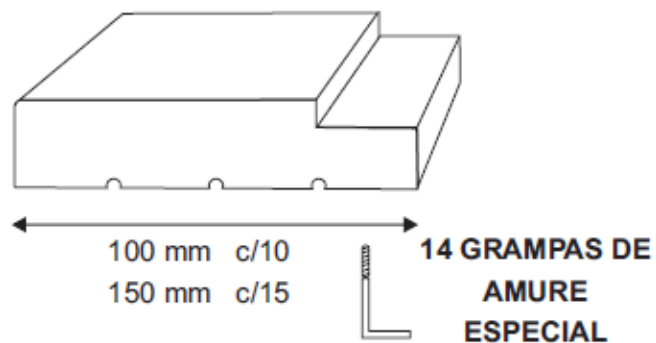

PINO FINGER

CARACTERÍSTICAS TÉCNICAS



- Hojas Doble contacto.
- Espesor 2" (pulgadas).
- Encolado sintético en prensa caliente homogeneizando la humedad.
- Panel nido de abeja celulósico.
- Cantos macizos en pino finger.
- Cerraduras metálica platil marca Cerratex.
- Pomela ficha con 3 tornillos platil.
- Protector plástico de obra.
- Hojas con separadores plásticos en su contorno para su perfecta colocación
- Agujeros de herrajes precisos
- Rebaje inferior, para evitar roturas
- Lijado automático con control de calidad.
- Todos los modelos se pueden combinar con ambos tipos de marcos

TABLA DE MEDIDAS

UNA HOJA

NOMINAL	60	70	80	90		
EXTERIOR	65	75	88	95	203	200

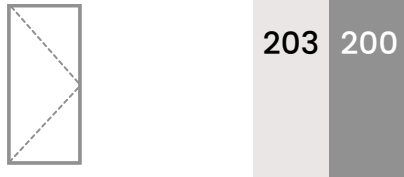

CORREDIZA EMBUTIR

NOMINAL	60	70	80	90		
EXTERIOR	126	146	166	186	206	200



DOS HOJAS

NOMINAL	60+60	70+70	80+80	90+90		
EXTERIOR	125	145	168	185	203	200

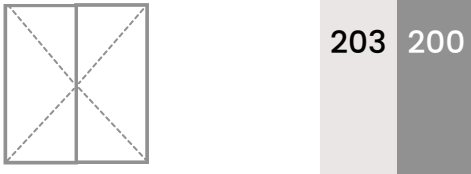

VISTA EXTERIOR

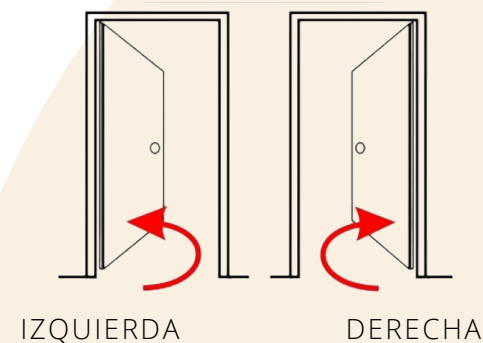

Medidas Exteriores en cm de marco a marco. Medidas nominales solo por denominacion comercial.



RINDER
PUERTAS & VENTANAS



12 CUOTAS
SIN INTERÉS!